

Reference Manual



GENERAL VEHICLE ELECTRONICS 2018



Technical Training

The information contained in this manual is not to be resold, bartered, copied or transferred without the express written consent of BMW of North America, LLC ("BMW NA").

Copyright © 2020 BMW of North America, LLC

Technical training.
Product information.

General Vehicle Electronics 2018



BMW Service

Edited for the U.S. market by:
BMW Group University
Technical Training

ST1856

7/1/2020

General information

Symbols used

The following symbol is used in this document to facilitate better comprehension or to draw attention to very important information:



Contains important safety information and information that needs to be observed strictly in order to guarantee the smooth operation of the system.

Information status: July 2018

BMW Group vehicles meet the requirements of the highest safety and quality standards. Changes in requirements for environmental protection, customer benefits and design render necessary continuous development of systems and components. Consequently, there may be discrepancies between the contents of this document and the vehicles available in the training course.

The information contained in the training course materials is solely intended for participants in this training course conducted by BMW Group Technical Training Centers, or BMW Group Contract Training Facilities.

This training manual or any attached publication is not intended to be a complete and all inclusive source for repair and maintenance data. It is only part of a training information system designed to assure that uniform procedures and information are presented to all participants.

For changes/additions to the technical data, repair procedures, please refer to the current information issued by BMW of North America, LLC, Technical Service Department.

This information is available by accessing TIS at www.bmwcenternet.com.

Additional sources of information

Further information on the individual topics can be found in the following:

- Owner's Handbook
- Integrated Service Technical Application
- Aftersales Information Research (AIR)

The information contained in this manual is not to be resold, bartered, copied, or transferred without the express written consent of BMW of North America, LLC ("BMW NA").

©2020 BMW of North America, LLC

The BMW name and logo are registered trademarks. All rights reserved.

General Vehicle Electronics 2018

Contents

1.	Introduction	1
2.	Electrical system > Service Pack 2018	2
2.1.	Overview of the vehicle electrical systems.....	2
3.	Bus Systems	3
3.1.	Bus overview.....	3
3.2.	Ethernet.....	6
3.3.	K-CAN6.....	9
4.	New Control Units	11
4.1.	Booster.....	11
4.2.	Driver Camera System (DCS).....	12
4.3.	Front radar sensor (FRS).....	13
4.4.	Front radar sensor long range (FRSF).....	13
4.5.	Rear radar sensor short range left (HRSNL).....	14
4.6.	Rear radar sensor short range right (HRSNR).....	14
4.7.	Camera-based driver assistance systems (KAFAS).....	15
4.7.1.	KAFAS mid.....	15
4.7.2.	KAFAS high.....	16
4.8.	NFC station.....	16
4.9.	Receiver Audio Module (RAM).....	17
4.10.	Side radar sensor short range front left (SRSNVL).....	18
4.11.	Side radar sensor short range front right (SRSNVR).....	18
4.12.	Virtual Integration Platform (VIP).....	19
4.13.	Wireless charging station (WCA/NFC).....	19
5.	Dual Storage System	21
5.1.	Wiring diagram.....	23
5.2.	Lithium ion battery.....	24
5.3.	Alternator.....	27
6.	ID Transmitter	28
6.1.	ID transmitter outside the vehicle.....	28
6.1.1.	ID transmitter sleeping.....	28
6.1.2.	ID transmitter awake.....	28
6.2.	ID transmitter in the vehicle.....	29
6.3.	Retrofitting ID Transmitter.....	29
6.3.1.	ID transmitter with movement sensor.....	29
6.3.2.	Check the ID transmitter.....	30
7.	Comfort Access 2.0	32

General Vehicle Electronics 2018

Contents

7.1.	Highlights / customer benefit.....	32
7.1.1.	Welcome effect.....	32
7.1.2.	Vehicle unlocking.....	33
7.1.3.	Vehicle locking.....	34
7.2.	Communication with ID transmitter.....	36
7.2.1.	Communication path.....	36
7.2.2.	Welcome effect.....	37
7.2.3.	Vehicle unlocking.....	38
7.2.4.	Vehicle locking.....	39
7.3.	Settings.....	40
7.3.1.	Automatic functions.....	40
7.3.2.	Selective unlocking.....	41
7.4.	Wiring diagram.....	41
8.	BMW Digital Key.....	44
8.1.	Introduction.....	44
8.2.	Functions.....	44
8.2.1.	Unlocking.....	44
8.2.2.	Vehicle starting.....	44
8.3.	Vehicle components.....	44
8.3.1.	Outside door handle electronics.....	44
8.3.2.	NFC station.....	45
8.3.3.	Wireless charging station.....	46
8.4.	Smartphone, Digital Key Card.....	46
8.4.1.	Digital Key Card.....	46
8.4.2.	Smartphone.....	47
9.	Wireless Technologies.....	48
9.1.	Comparison of wireless technologies.....	48
9.1.1.	ID transmitter.....	49
9.1.2.	NFC.....	49
9.1.3.	Bluetooth.....	49
10.	Drive Recorder.....	50
10.1.	Introduction.....	50
10.2.	Function.....	50
11.	Changelog.....	51

General Vehicle Electronics 2018

1. Introduction

The new features for the:

- Vehicle electrical system
- Control units
- Voltage supply
- Comfort Access 2.0

are described for all models in this document.

The following vehicles have acquired the corresponding new features:

- G05
- G14/G15/G16
- G12 LCI
- G20
- G29

Depending on the model and national-market versions, not all vehicles acquire all the new features.

General Vehicle Electronics 2018

2. Electrical system > Service Pack 2018

2.1. Overview of the vehicle electrical systems

The vehicle electrical system 2020 (BN2020) was introduced in the F01. The predecessor system is called BN2000.

The vehicle electrical system must be adapted to new systems, functions, components and requirements. The corresponding changes are effected by Service Packs.



Electrical system history

Index	Explanation
1	Service Pack 2013 introduction with F15/I01/I12
2	Service Pack 2015 introduction with G12
3	Service Pack 2018 introduction with G05

Subnetwork operation for entertainment and charging was introduced with Service Pack 2013.

Parking-residing-driving terminal control was introduced with Service Pack 2015.

The following are introduced with Service Pack 2018:

- Remote Software Upgrade RSU
- Comfort Access 2.0
- BMW Digital Key

Remote Software Upgrade enables the software in customer vehicles to be remotely updated. A Remote Software Upgrade is a service in combination with the back end of ConnectedDrive which facilitates the following:

- Updating of functions and information in customer vehicles.
- Fast and convenient updating of defective software in customer vehicles.
- Rapid elimination of possible security flaws in the software.

General Vehicle Electronics 2018

3. Bus Systems

3.1. Bus overview

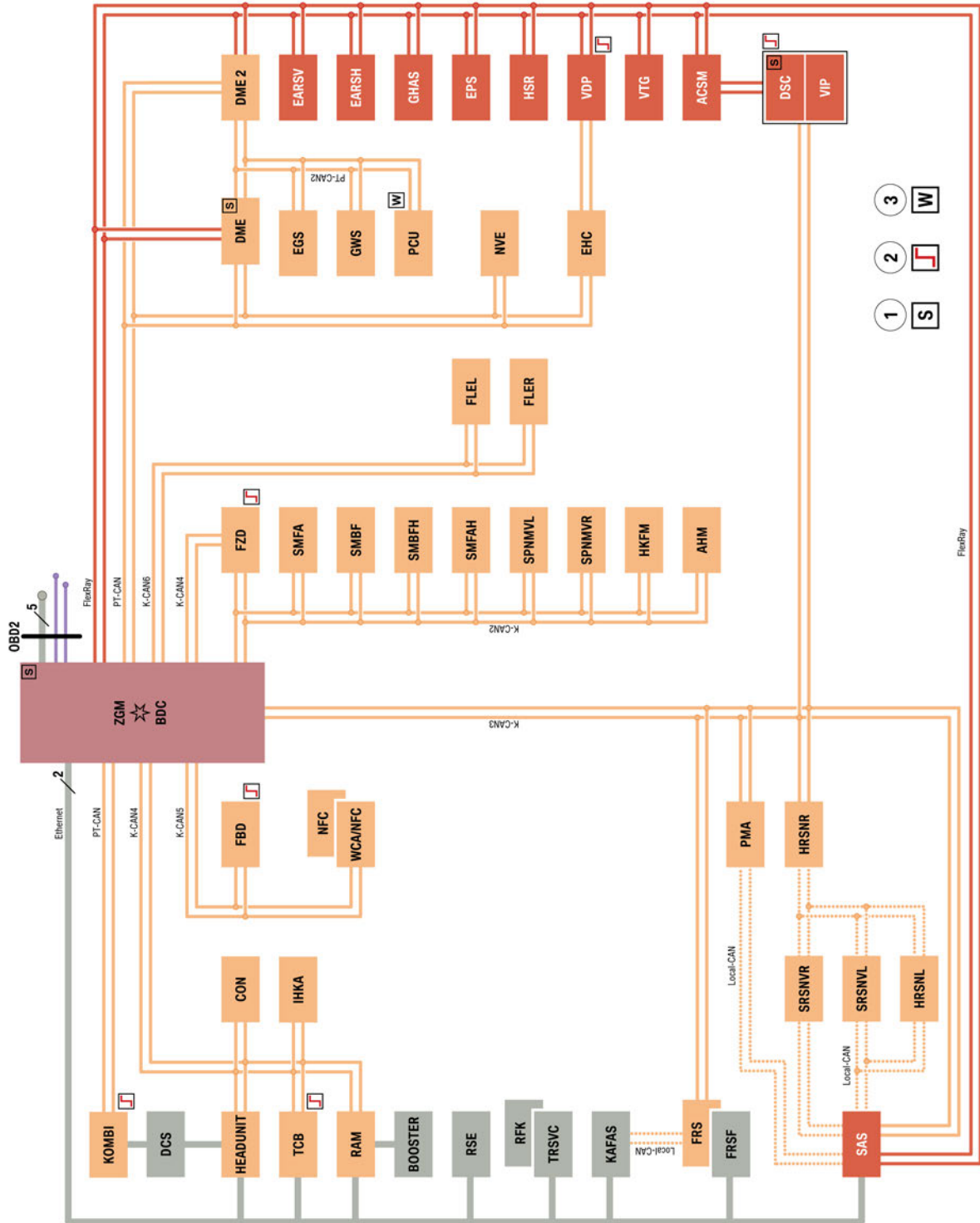

TE18-0286_2

G05 Bus overview example

General Vehicle Electronics 2018

3. Bus Systems

Index	Explanation
ACSM	Advanced Crash Safety Module
AHM	Trailer module
BDC	Body Domain Controller
Booster	Booster
CON	Controller
DCS	Driver Camera System
DME	Digital Motor Electronics
DME2	Digital Motor Electronics 2
DSC	Dynamic Stability Control ¹
EARSH	Electric active roll stabilization rear
EARSV	Electric active roll stabilization front
EGS	Electronic transmission control
EHC	Electronic ride height control
EPS	Electromechanical Power Steering
FBD	Remote control receiver
FLER	Frontal Light Electronics Right
FLEL	Frontal Light Electronics Left
FRS	Front radar sensor
FRSF	Front radar sensor long range
FZD	Roof function centre
GHAS	Regulated rear axle differential lock
GWS	Gear selector switch
HU-H	Head Unit High
HKFM	Tailgate function module
HRSNL	Rear radar sensor short range left
HRSNR	Rear radar sensor short range right
IHKA	Integrated automatic heating / air conditioning
KAFAS	Camera-based driver assistance systems
KOMBI	Instrument cluster
NFC	Near Field Communication
PCU	Power Control Unit
PMA	Parking Manoeuvring Assistant
RAM	Receiver Audio Module
RFK	Rear view camera
RSE	Rear Seat Entertainment

General Vehicle Electronics 2018

3. Bus Systems

Index	Explanation
SAS	Optional equipment system
SMBF	Front passenger seat module
SMFA	Driver's seat module
SMBFH	Rear front-passenger side seat module
SMFAH	Rear driver's side seat module
SPNMVL	Seat pneumatics module front left
SPNMVR	Seat pneumatics module front right
SRSNVL	Side radar sensor short range front left
SRSNVR	Side radar sensor short range front right
TCB	Telematic Communication Box
TR SVC	Top rear side view camera
VDP	Vertical Dynamic Platform
VIP	Virtual Integration Platform ¹
VTG	Transfer box
WCA/NFC	Wireless charging station with control electronics for Near Field Communication
ZGM	Central Gateway Module
1	Start-up node control units for starting and synchronizing the FlexRay bus system
2	Control units authorized to perform wake-up function
3	Control units also connected at terminal 15WUP

¹Depending on the brake system, Dynamic Stability Control (DSC) is installed with or without the Virtual Integration Platform (VIP).

Depending on the optional equipment, the control unit for the rear view camera and SideView TR SVC or rear view camera RFK is installed.

Changes with Service Pack 2018:

- There is no MOST in vehicles with a new head unit
- Depending on the optional equipment, the front radar sensor (FRS) or the front radar sensor long range (FRSF) is installed
- With the optional equipment air suspension on both axles electronic ride height control (EHC) is used in conjunction with the Vertical Dynamic Platform (VDP)
- The antenna and the control electronics for Near Field Communication have additionally been installed in the wireless charging station (WCA/NFC)
- An NFC station is installed in vehicles with the optional equipment Comfort Access without wireless charging station (WCA/NFC).

General Vehicle Electronics 2018

3. Bus Systems

Omitted control units:

- The Light Effect Manager (LEM) is omitted. Actuation of the LEDs of the panorama roof is performed by the Body Domain Controller (BDC). Actuation of the LEDs of the speakers in the HIGH-End audio system is performed by the Receiver Audio Module (RAM).
- Active Sound Design is omitted. Active Sound Design has been integrated in the Receiver Audio Module (RAM). If necessary, the booster is still required for the outside sound.
- The high-beam assistant (FLA) is omitted from all European versions. The function is performed by the camera-based driver assistance systems (KAFAS).

3.2. Ethernet

The established 2-wire OABR Ethernet (OPEN Alliance BroadR-Reach) is used in all vehicles. The Ethernet variant with 5 lines (4 data lines and 1 activation line) is still used by the OBD2 interface to the Body Domain Controller (BDC).

The standard "Open Alliance BroadR-Reach" (OABR Ethernet) has been specially developed as a new data transmission layer for use in vehicles. OABR Ethernet only requires an unshielded twisted two-wire connection. If the Ethernet line is situated in the area of antennas in the vehicle, this is if necessary shielded in order to avoid interference. OABR Ethernet supports bidirectional 100 MBit/s communication between 2 nodes. This means that both nodes can simultaneously send and receive at a data transfer rate of 100 MBit/s. OABR Ethernet requires point-to-point networking. This means that the bus system is not split up between multiple nodes, as is the case e.g. with CAN (Controller Area Network) systems. Instead, Ethernet switches are used for the connection of further nodes.

Ethernet switches are integrated in the following control units:

- Body Domain Controller (BDC)
- Optional equipment system (SAS)
- Head Unit High 3 (HU-H3).

The top rear side view camera (TRSVC) is the master and the Ethernet switch for the:

- Front camera
- Exterior mirror camera, left
- Exterior mirror camera, right
- Rear view camera

The instrument cluster (KOMBI) is connected to the Driver Camera System (DCS) by Ethernet.

The Receiver Audio Module (RAM) is the master for the booster.

The booster is not shown by the ISTA diagnosis system in the bus overview.

General Vehicle Electronics 2018

3. Bus Systems

In vehicles with the Head Unit High 3 (HU-H3) the following control units are connected directly to the head unit:

- Telematic Communication Box (TCB)
- Rear Seat Entertainment (RSE)
- Driver Camera System (DCS)
- and Receiver Audio Module (RAM)

As a result, the Ethernet interfaces on the Body Domain Controller (BDC) are sufficient, and no additional Ethernet switch (ENS) is required.

An Ethernet switch (ENS) is used in vehicles with the Head Unit Basic, depending on the vehicle equipment. In the event of failure of an Ethernet switch, all bus users connected by it are disconnected from the rest of the network and are no longer able to communicate via Ethernet.

In the wiring diagram the connection of the top rear side view camera (TRSVC) control unit and rear view camera (RFK) is shown. In the vehicle, either TRSVC is installed for a vehicle with multiple cameras, or RFK for a vehicle with a rear view camera (standalone).

The wiring diagram shows the Ethernet on the example of the G05.

General Vehicle Electronics 2018

3. Bus Systems

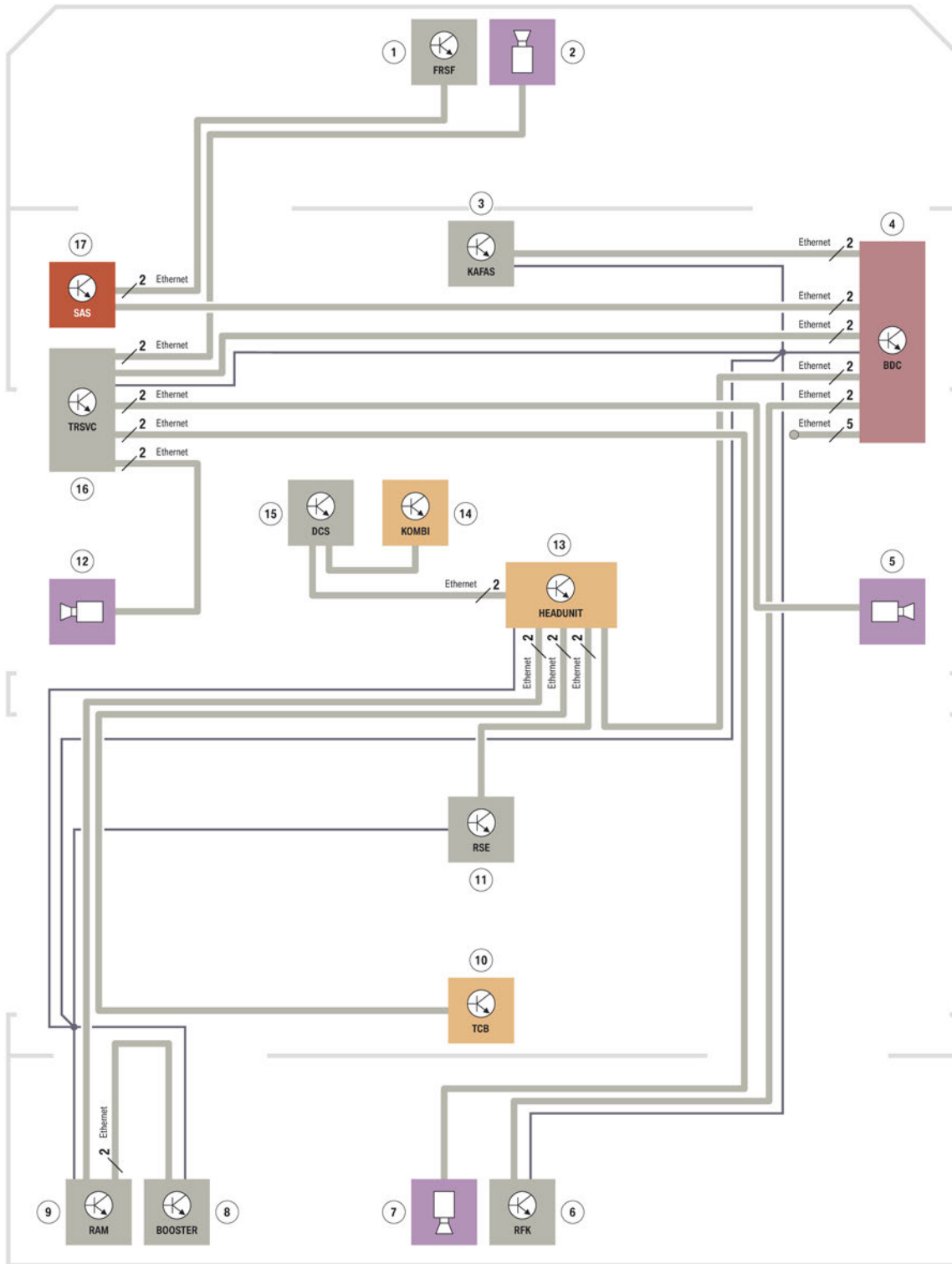

Ethernet

TE17-2255

General Vehicle Electronics 2018

3. Bus Systems

Index	Explanation
1	Front radar sensor long range (FRSF)
2	Front camera
3	Camera-based driver assistance systems
4	Body Domain Controller
5	Exterior mirror camera, right
6	Rear view camera (RFK) (single camera without KAFAS)
7	Rear view camera
8	Booster
9	Receiver Audio Module (RAM)
10	Telematic Communication Box 2 (TCB2)
11	Rear Seat Entertainment (RSE)
12	Exterior mirror camera, left
13	Head Unit
14	Instrument cluster (KOMBI)
15	Driver Camera System (DCS)
16	Top Rear Side View Camera (TRSVC)
17	Optional equipment system (SAS)

3.3. K-CAN6

The control units Frontal Light Electronics Left (FLEL) and Frontal Light Electronics Right (FLER) were previously connected to the K-CAN3.

An additional K-CAN for the light control units was introduced with the vehicle electrical system structure 2018.

General Vehicle Electronics 2018

3. Bus Systems

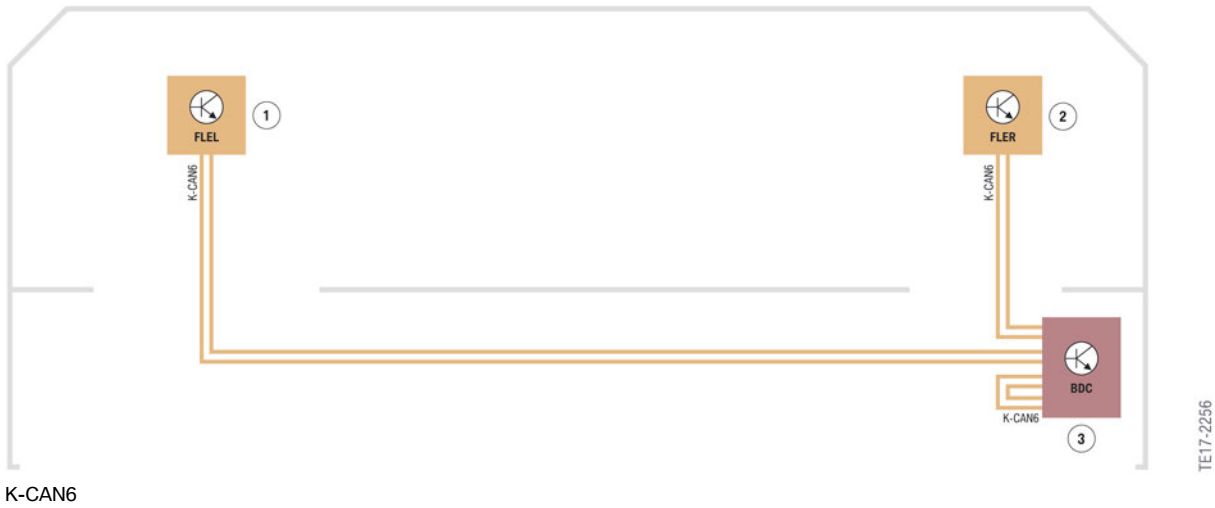

Index	Explanation
1	Frontal Light Electronics Left (FLEL)
2	Frontal Light Electronics Right (FLER)
3	Body Domain Controller (BDC)

General Vehicle Electronics 2018

4. New Control Units

Information on new control units and on control units which have been adapted for the vehicle electrical system 2018.

4.1. Booster

An additional booster is installed, depending on the audio variant.

Normally there is no booster in stereo and hi-fi systems. However, if an outside speaker is required for the outside sound on a vehicle, depending on the engine version, a booster is installed.

Detailed information can be found in the document “ST1857 Infotainment 2018”.

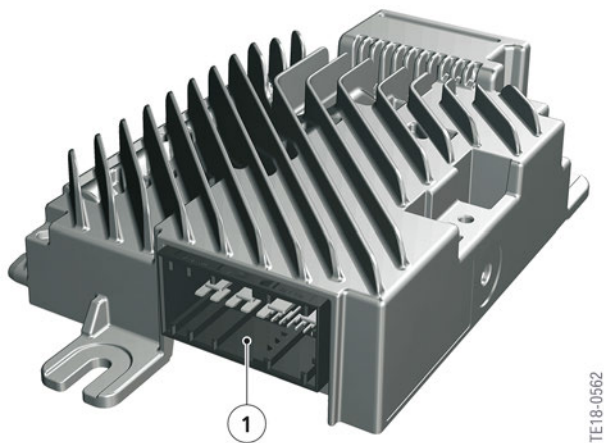

Booster

Index	Explanation
1	Connections for speaker, voltage supply, Ethernet connection

General Vehicle Electronics 2018

4. New Control Units

4.2. Driver Camera System (DCS)

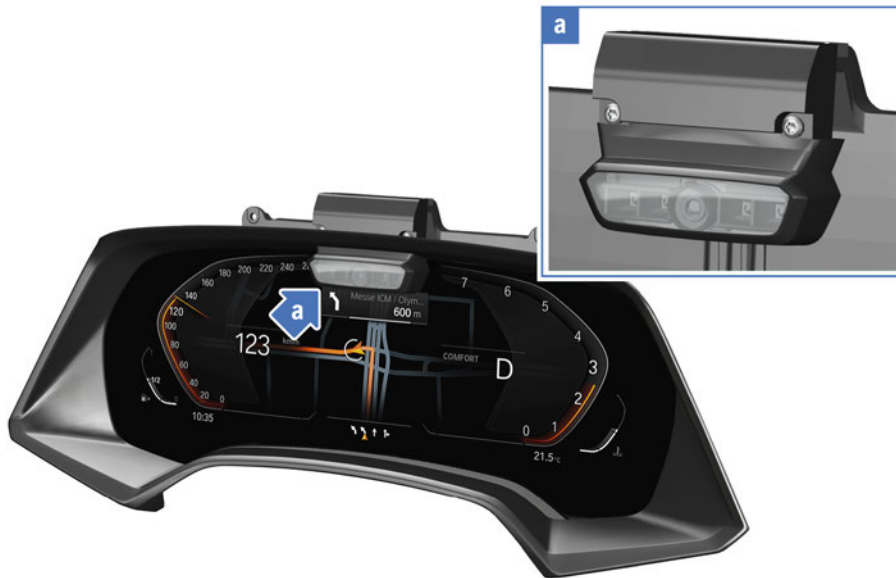

Instrument cluster with Driver Camera System (DCS)

The Driver Camera System (DCS) is a camera installed in the instrument cluster directed at the driver.

Detailed information can be found in the document “ST1858 Driver Assistance Systems 2018”.

General Vehicle Electronics 2018

4. New Control Units

4.3. Front radar sensor (FRS)



TE18-0174

Front radar sensor (FRS)

The front radar sensor (FRS) supplies the input data for:

- Collision warning
- Person/cyclist warning
- Cruise control with braking function
- Active Cruise Control with Stop&Go function
- Distance information

4.4. Front radar sensor long range (FRSF)



TE18-0175

Front radar sensor long range (FRSF)

General Vehicle Electronics 2018

4. New Control Units

The front radar sensor long range (FRSF) is installed with the optional equipment Driving Assistant Professional.

The FRSF supplies the input data for the longitudinal and lateral guidance and safety assistance systems.

The front radar sensor long range (FRSF) is a further development of Active Cruise Control (ACC).

4.5. Rear radar sensor short range left (HRSNL)



Rear radar sensor short range left (HRSNL)

The rear radar sensor short range left (HRSNL) is a further development of lane change warning (secondary) (SWW2).

4.6. Rear radar sensor short range right (HRSNR)



Rear radar sensor short range right (HRSNR)

The rear radar sensor short range right (HRSNR) is a further development of lane change warning (primary) (SWW).

General Vehicle Electronics 2018

4. New Control Units

4.7. Camera-based driver assistance systems (KAFAS)



Camera-based driver assistance systems (KAFAS)

Index	Explanation
A	KAFAS mid
B	KAFAS high

Depending on the assistance system, 2 different cameras are used for KAFAS.

- KAFAS mid
- KAFAS high.

4.7.1. KAFAS mid

KAFAS mid is equipped with a single camera.

Functions:

- Detection of lanes
- Detection of vehicles
- Detection of persons
- Detection of signs and traffic lights

General Vehicle Electronics 2018

4. New Control Units

4.7.2. KAFAS high

KAFAS high is equipped with a triple camera with 3 camera lens with different aperture angles of 28°, 52° and 152°. This enables more situations to be recorded with better quality.

Functions:

- Detection of lanes
- Detection of vehicles
- Detection of persons
- Detection of signs and traffic lights
- Detection of stop lines
- Detection of side road boundaries
- Detection of landmarks
- Detection of clearances

4.8. NFC station



NFC station

An NFC station is installed with the optional equipment Comfort Access (SA 322) in vehicles with a wireless charging stations.

Feature distinguishing an NFC station from a wireless charging station (WCA/NFC):

- There is no LED on the NFC station
- An LED for the charging function is incorporated on the wireless charging station (WCA/NFC).

The NFC control unit is not shown by the ISTA diagnosis system in the bus overview. Diagnosis is performed via the Body Domain Controller.

General Vehicle Electronics 2018

4. New Control Units

4.9. Receiver Audio Module (RAM)

The Receiver Audio Module (RAM) comes in a variety of versions and power levels.

Different housing shapes are used, depending on the components installed. Detailed information about the different versions can be found in the document “ST1857 Infotainment 2018”.

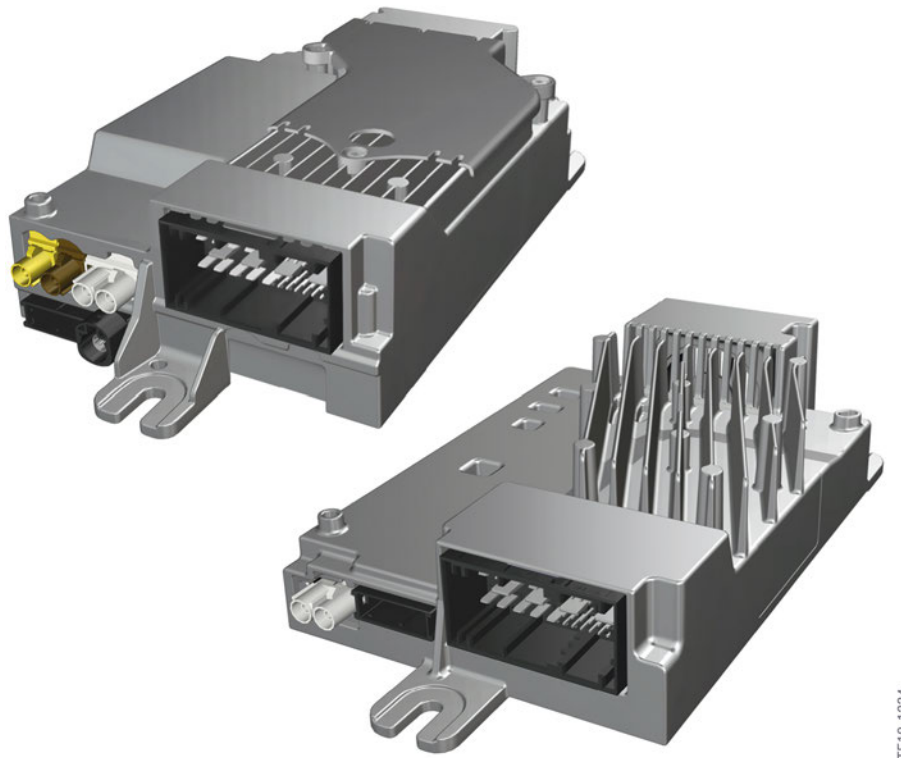

Receiver Audio Module (RAM)

Depending on the number and power of the speakers, a booster, to which the audio data are streamed via an Ethernet connection, is additionally installed.

The Receiver Audio Module (RAM) is a control unit and part of the infotainment system. The Receiver Audio Module (RAM) is an audio amplifier with integrated tuners and an integrated sound processor.

The Receiver Audio Module (RAM) also contains Active Sound Design (ASD), and therefore an additional control unit is not required.

The following tuners can be installed:

- SDARS
- FM
- AM

The RAM control unit is connected via Ethernet to the head unit. Audio control is performed by the head unit.

General Vehicle Electronics 2018

4. New Control Units

4.10. Side radar sensor short range front left (SRSNVL)



Side radar sensor short range front left (SRSNVL)

The side radar sensor short range front left (SRSNVL) is a further development of the radar sensor left (RSL).

4.11. Side radar sensor short range front right (SRSNVR)



Side radar sensor short range front right (SRSNVR)

The side radar sensor short range front right (SRSNVR) is a further development of the radar sensor right (RSR).

General Vehicle Electronics 2018

4. New Control Units

4.12. Virtual Integration Platform (VIP)



Dynamic Stability Control (DSC) with Virtual Integration Platform (VIP)

On vehicles with integrated brake systems, the Virtual Integration Platform (VIP) is integrated in the brake system in addition to Dynamic Stability Control (DSC). The control unit for the integrated brake system is made up of Dynamic Stability Control (DSC) and Virtual Integration Platform (VIP). Thus 2 control units are provided for diagnosis and programming with the ISTA diagnosis system. The segmentation makes it easier to adapt to future vehicles. The DSC main functions will remain the same in other vehicles, therefore no changes are made to Dynamic Stability Control (DSC). Adaptation of the Virtual Integration Platform (VIP) makes it easier to adapt to future vehicles and driver assistance systems.

4.13. Wireless charging station (WCA/NFC)

The antenna and the control electronics for Near Field Communication (NFC) have additionally been installed in the wireless charging station.



Wireless charging station with Near Field Communication (NFC)

General Vehicle Electronics 2018

4. New Control Units

The wireless charging station (WCA) monitors the charging bay and controls the charging procedure.

The Near Field Communication (NFC) control electronics is required for Near Field Communication in the vehicle.

The WCA/NFC control unit is not shown by the ISTA diagnosis system in the bus overview. Diagnosis is performed via the Body Domain Controller (BDC).

General Vehicle Electronics 2018

5. Dual Storage System

The dual storage system serves to support the vehicle electrical system. A 12 V lithium ion battery and a 12 V lead-acid battery are installed for this purpose. The dual storage system serves to power the vehicle electrical power system in a safe and reliable way.

The two batteries are connected in parallel and are isolated only in the event of a fault by the battery isolating switch installed in the lithium ion battery.

The dual storage system is installed:

- so that the emissions threshold values are adhered to
- if necessary instead of the familiar vehicle electrical system support with a 50 Ah or 60 Ah lead-acid battery and Power Control Unit (PCU).

Depending on:

- the engine version
- the optional equipment

the dual storage system is installed.

Exception:

The vehicle electrical system support with a 50 Ah or 60 Ah lead- acid battery and Power Control Unit (PCU) is installed in vehicles with electric active roll stabilization.

Benefits from the dual storage system:

- Reduced CO₂
- Weight saving with regard to vehicle electrical system support with AGM battery
- Emergency starting function

The lithium ion battery can be charged or discharged with higher currents than a lead-acid battery. In this way, more energy can be stored for example in coasting overrun mode and exported where necessary. This results in a reduction in CO₂ emissions.

If the dual storage system is installed instead of the vehicle electrical system support with lead-acid battery, a weight saving of 17 kg (37 lbs) or 19 kg (42 lbs) is made, depending on the capacity of the lead-acid battery.

If the starter battery is so flat that the engine cannot be started, the engine can if necessary be started via the lithium ion battery.

CO₂ potential through energy recovery (1-2 g/km)

The dual storage system improves the energy recover capability of the 12 V system. The energy recovery power output increases from approx. 0.5 kW to approx. 2 kW. This enables a large part of the base load in the vehicle to be compensated. In this way, the drivetrain is only subjected to minimal load by the alternator during acceleration phases.

MSA start quality

The lithium ion battery increases the power output at the starter motor. Improved engine starting reduces the engine vibrations.

General Vehicle Electronics 2018

5. Dual Storage System

Protection of the lead-acid battery

Thanks to the dual storage system the cyclization of the lead-acid battery is dramatically reduced and taken on by the lithium ion battery. This significantly prolongs the service life of the lead-acid battery.

General Vehicle Electronics 2018

5. Dual Storage System

Index	Explanation
1	Alternator
2	Starter motor
3	Power distribution box, engine compartment
4	Lithium ion battery
5	Power distribution box, front right
6	Body Domain Controller (BDC)
7	Power distribution box, rear
8	Battery power distribution box
9	Safety battery terminal
10	Battery
11	Intelligent battery sensor
12	Advanced Crash Safety Module (ACSM)
13	Integrated supply module
14	Digital Motor Electronics (DME)

5.2. Lithium ion battery

Nominal voltage 12 V, capacity 10 Ah.

The lithium ion battery contains the battery monitoring electronics and the battery isolating switch.

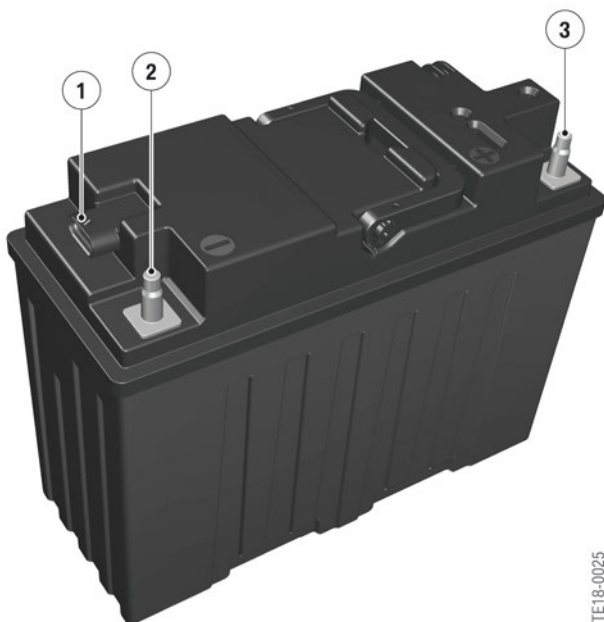

Lithium ion battery

TE18-0025

General Vehicle Electronics 2018

5. Dual Storage System

Index	Explanation
1	Plug connector
2	Negative terminal
3	Positive terminal

Connections on the lithium ion battery:

- Positive terminal
- Negative terminal

Plug connector with the terminals:

- Terminal 30B
- Terminal 30C
- LIN

The battery monitoring electronics is powered via terminal 30B.

Terminal 30C from the safety battery terminal is additionally connected to the lithium ion battery. This ensures that the lithium ion battery is also shut down when the safety battery terminal is triggered.

Communication is performed via LIN with the Digital Motor Electronics (DME).

Battery monitoring electronics

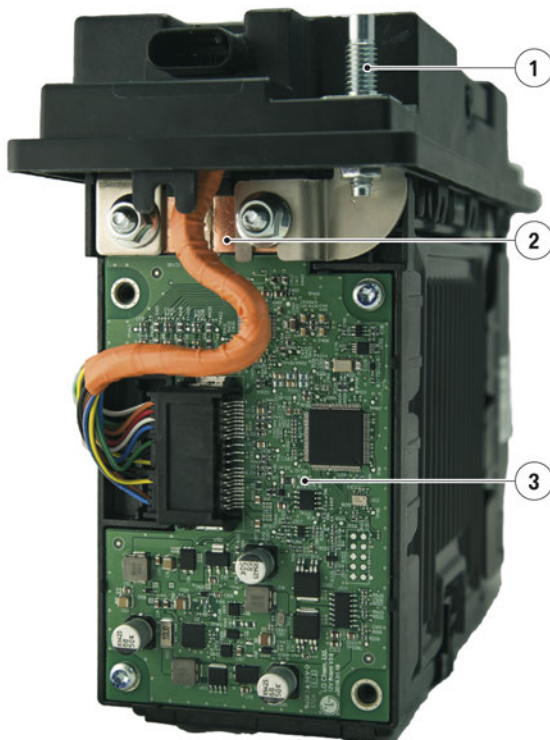

TE18-0677

Lithium ion battery

General Vehicle Electronics 2018

5. Dual Storage System

Index	Explanation
1	Negative terminal
2	Measuring resistor (shunt) for current measurement
3	Battery monitoring electronics

Purposes of the battery monitoring electronics:

- Communication via LIN data bus with DME
- Current monitoring
- Standby current monitoring
- Voltage monitoring
- Temperature monitoring
- Cell voltage monitoring
- Actuation of the battery isolating switch
- Diagnosis

Battery isolating switch

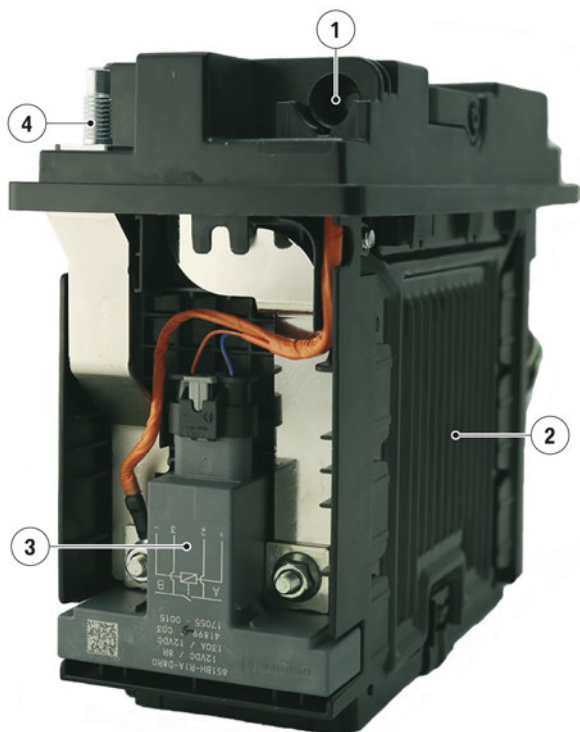

Lithium ion battery

TE18-0676

General Vehicle Electronics 2018

5. Dual Storage System

Index	Explanation
1	Ventilation connection
2	Housing for lithium ion cells
3	Battery isolating switch
4	Positive terminal

The battery isolating switch is actuated by the battery monitoring electronics and serves to protect the lithium ion battery.

If the permissible values for:

- Voltage
- Current
- Temperature
- State of charge

are exceeded or undershot, the battery isolating switch opens to prevent damage to the lithium ion battery.

The battery isolating switch is automatically closed when the permissible values are reached.

The battery isolating switch is opened when the safety battery terminal of the vehicle battery is triggered. The battery isolating switch is closed only after repair has been completed and with terminal 30C available.

Digital Motor Electronics (DME)

The Digital Motor Electronics (DME) is responsible for:

- charge control
- diagnosis of the lithium ion battery
- registration of battery exchange



The maximum charging voltage of the lithium ion battery must not be exceeded. Therefore, use chargers recommended by BMW with the corresponding function software for lithium ion batteries.

5.3. Alternator

The alternator power has been increased to 250 A. Alternator regulation has been optimized by active alternator power regulation (AGLR). A higher energy recovery power output is made possible by these adaptations.

General Vehicle Electronics 2018

6. ID Transmitter

The ID transmitter is equipped with a motion sensor.

The ID transmitter is already incorporated in current G series as of March 2018 and is not a Service Pack 2018 measure. All G series with Comfort Access receive this ID transmitter.

6.1. ID transmitter outside the vehicle



ID transmitter outside the vehicle

Index	Explanation
A	ID transmitter sleeping (no motion detected)
B	ID transmitter awake (motion detected)

6.1.1. ID transmitter sleeping

If no motion is detected by the ID transmitter because it is lying for example on a table, it goes to sleep after 2 minutes. Hence, no communication is possible from the vehicle to the ID transmitter. The vehicle cannot be unlocked or started with a wireless range extender whereby the wireless path from and to the vehicle is increased. This measure thus effectively prevents vehicle theft using this method.

6.1.2. ID transmitter awake

The ID transmitter is woken by:

- detection of motion
- or operation of a button.

This re-establishes communication with the vehicle.

General Vehicle Electronics 2018

6. ID Transmitter

6.2. ID transmitter in the vehicle



ID transmitter in the vehicle

If the ID transmitter is in the vehicle, it must remain awake so that communication with the vehicle is possible. Communication with the ID transmitter occurs when the start/stop button is operated. Engine starting would not be possible if the ID transmitter were sleeping.

If the ID transmitter is in the vehicle, communication occurs every 45 minutes:

- from the vehicle to the ID transmitter
- and from the ID transmitter to the vehicle.

This prevents the ID transmitter from going to sleep.

If an ID transmitter is in the vehicle, it goes to sleep when the vehicle is locked or doublelocked with a different ID transmitter.

6.3. Retrofitting ID Transmitter

To increase the anti-theft in vehicles equipped with Comfort Access (SA 322), a new generation of ID transmitters is available.

6.3.1. ID transmitter with movement sensor

The new generation ID transmitter is equipped with a movement sensor and is used in all vehicles of the G series from production month March 2018.

Outside the vehicle, the new generation ID transmitter, which is in the idle state, switches off after approximately 2 minutes. This means that the ID transmitter can no longer be affected by the method of extending the wireless range.

The ID transmitter is automatically activated by movement.

General Vehicle Electronics 2018

6. ID Transmitter

The new ID transmitter can be retrofitted to vehicles in the G series equipped with Comfort Access manufactured before March 2018.

The retrofit is carried out by the request of the customer at a cost.

6.3.2. Check the ID transmitter

Before ordering a new ID transmitter, it is necessary to check whether the ID transmitter already contains a movement sensor.

With “normal” ID transmitter:

- Open cover to battery compartment.
- Check information label on the back of the cover.

M/N: ID2A no movement sensor

M/N: ID21A contains movement sensor (exchange not necessary)

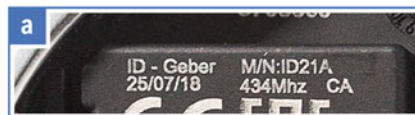

TE18-2582

ID transmitter

General Vehicle Electronics 2018

6. ID Transmitter

With BMW display key:

- In the submenu of the BMW display key, click three times quickly on the large window symbol; the version appears in the window e.g. 015.050.053.
- If 015 or higher appears at the start of the version number, the BMW display key is equipped with a movement sensor. (no exchange is needed)



BMW display key

Index	Explanation
1	Window symbol

Retrofitting is available for G series from 06/2018.

General Vehicle Electronics 2018

7. Comfort Access 2.0

New and additional functions of Comfort Access 2.0:

- Welcome effect
- Vehicle unlocking
- Vehicle locking

7.1. Highlights / customer benefit

The customer only needs to have the ID transmitter with them. No actuation is required.

The specified distances are approximate values and may vary in the different model series.

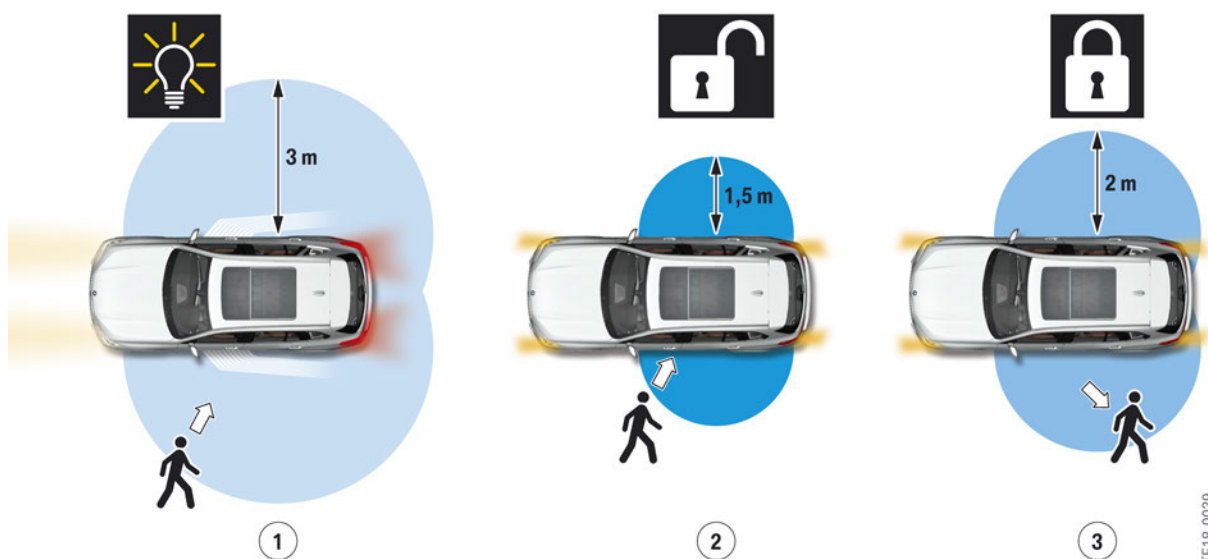

Comfort Access 2.0

Index	Explanation
1	Welcome effect on approaching the vehicle
2	Unlocking of doors on approaching the vehicle further
3	Locking of deadlocking of doors on moving away from the vehicle ¹

¹The doors are locked or doublelocked, depending on whether there are still persons inside the vehicle.

7.1.1. Welcome effect

Welcome effect on approaching the vehicle.

The graphic shows the driver's side, the function on the passenger's side is identical!

General Vehicle Electronics 2018

7. Comfort Access 2.0

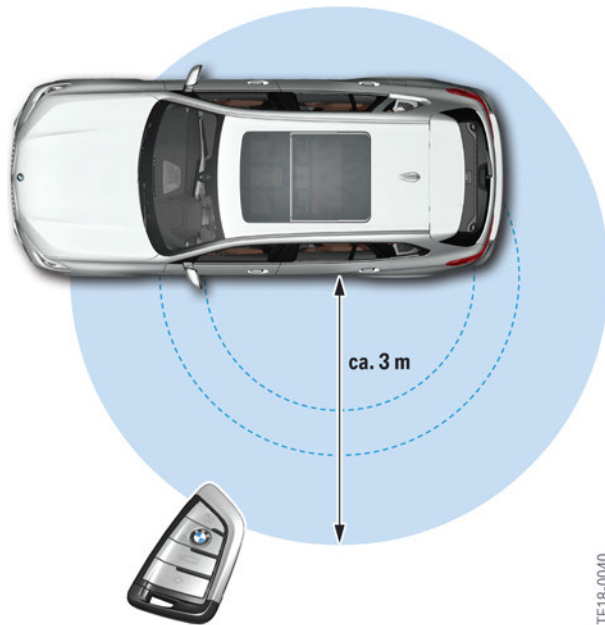

Welcome effect

When the customer approaches the vehicle with the ID transmitter, the Welcome effect starts at a distance of approx. 3 m (10ft).

The following functions are activated, depending on the model version, and the optional equipment:

- Welcome light
- Interior light
- Ground lights
- Light carpet

7.1.2. Vehicle unlocking

Unlocking of doors on approaching the vehicle further.

The graphic shows the driver's side, the function on the passenger's side is identical!

General Vehicle Electronics 2018

7. Comfort Access 2.0

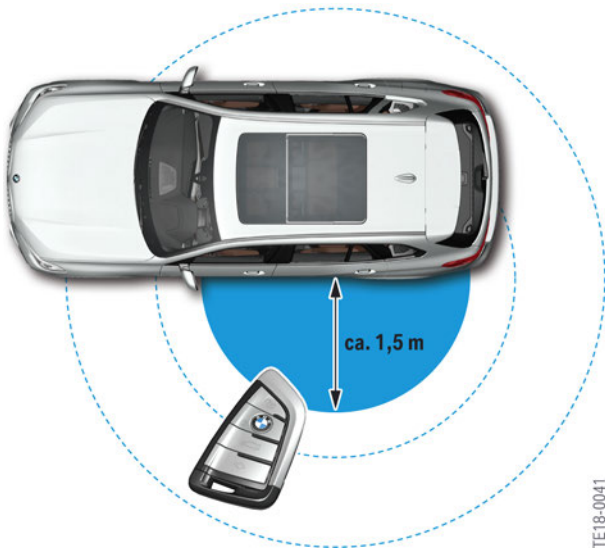

Vehicle unlocking

When the customer moves closer to the vehicle with the ID transmitter, the vehicle is unlocked at a distance of approx. 1.5 m (5 ft.).

Depending on the settings in the Central Information Display:

- selectively only the driver's door
- or all the doors are unlocked.

7.1.3. Vehicle locking

Locking of doors on moving away from the vehicle

The graphic shows the driver's side, the function on the passenger's side is identical!

General Vehicle Electronics 2018

7. Comfort Access 2.0

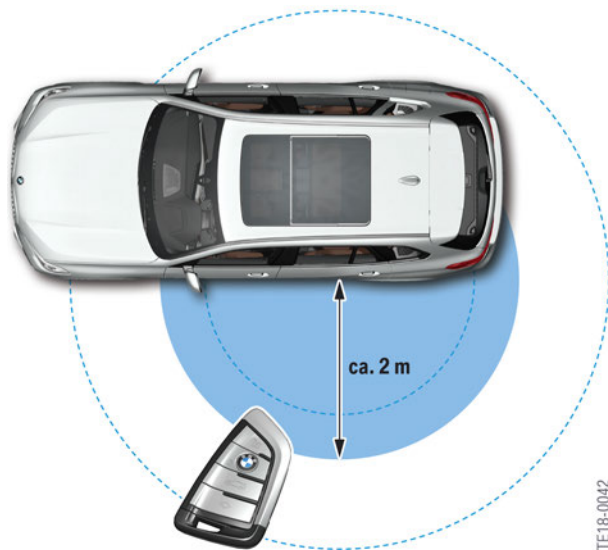

Vehicle locking

When the customer leaves the vehicle range with the ID transmitter, the vehicle is automatically locked or doublelocked at a distance of approx. 2 m (6 ft.).

Prerequisites for locking:

- Driver's door opened and closed again
- All doors closed
- No driving readiness
- ID transmitter is, when the last door is closed, in the range of max. 3 m (10 ft.) distance from the vehicle.

Additional prerequisites for doublelocking:

- Seat belt buckle contact not connected
- Seat occupancy detection does not detect any person.

Persons in the vehicle

If there are still persons inside the vehicle, the vehicle is only locked and the alarm system is not activated.

ID transmitter in the vehicle

If an ID transmitter is still in the vehicle, it is deactivated on locking for the unlocking function and the vehicle is locked or doublelocked. Only after the vehicle is unlocked with a different ID transmitter is the ID transmitter located in the vehicle activated again.

General Vehicle Electronics 2018

7. Comfort Access 2.0

7.2. Communication with ID transmitter

7.2.1. Communication path

The graphic shows the driver's side, the function on the passenger's side is identical!

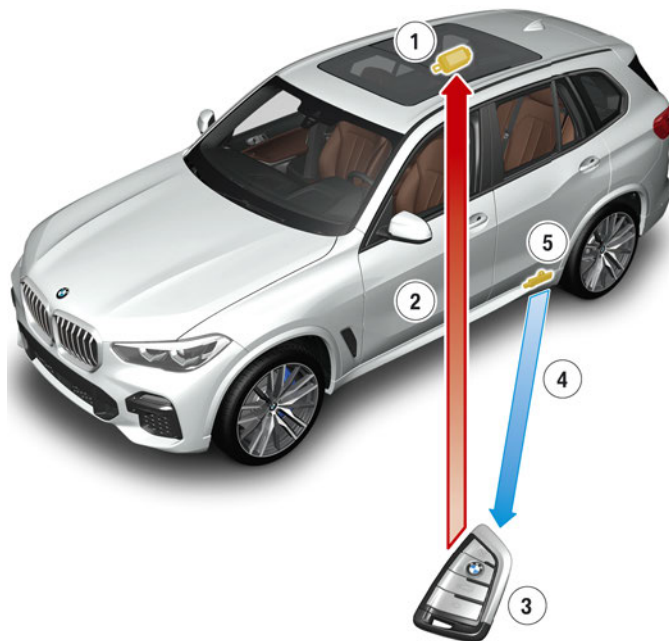

TE18-0043

Communication path

Index	Explanation
1	Remote control receiver (FBD)
2	Communication 434 MHz ¹
3	ID transmitter
4	Communication 125 kHz
5	Comfort Access antenna, side sill, left

¹Frequency dependent on the national-market version.

Comfort Access antennas in the side sill

When the vehicle is exited, the Comfort Access antennas in the left and right side sills are activated by the Body Domain Controller (BDC).

Both antennas are also activated when selective unlocking is set. Selective unlocking is a key function and accordingly only active on the corresponding ID transmitter. This makes it possible to unlock the vehicle from the passenger's side with a different ID transmitter on which selective unlocking is not active.

General Vehicle Electronics 2018

7. Comfort Access 2.0

The Comfort Access antennas in the left and right side sills transmit every 0.4 s at a frequency of 125 kHz. If there is no ID transmitter in the transmission range of the antennas, these are activated with 400 mA per antenna.

If an ID transmitter is in the transmission range of the antennas, activation per antenna is reduced to 50 mA, depending on the distance between the ID transmitter and the vehicle. To prevent the vehicle battery from being excessively discharged, the Comfort Access antennas are deactivated after the vehicle has stood idle for 3 days. A driving cycle must happen in order to reactivate this function. In this way, the automatic functions are inactive without actuation by the customer. Comfort Access functions with deactivated antennas as in the 1st generation.

ID transmitter

When an ID transmitter receives a signal from a Comfort Access antenna in the side sill, it transmits a message to the remote control receiver (FBD). The ID transmitter transmits, depending on the field strength of the signal received, a corresponding message to the remote control receiver. This message is evaluated and consequently the distance is determined by the Body Domain Controller (BDC). The different actions can therefore be activated, depending on the distance between the ID transmitter and the vehicle.

7.2.2. Welcome effect

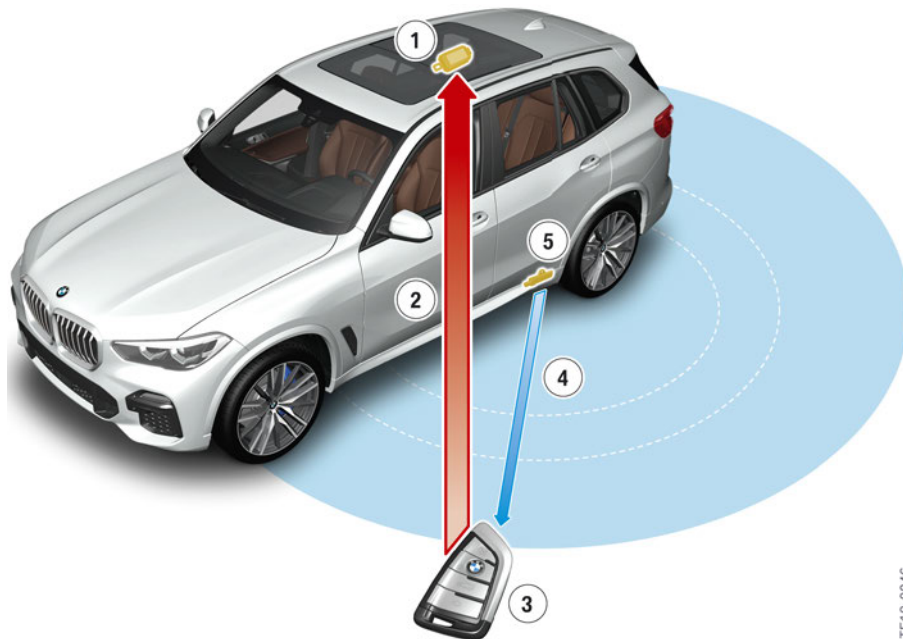

Welcome effect

TE18-0046

General Vehicle Electronics 2018

7. Comfort Access 2.0

Index	Explanation
1	Remote control receiver (FBD)
2	Communication 434 MHz ¹
3	ID transmitter
4	Communication 125 kHz
5	Comfort Access antenna, side sill, left
6	Comfort Access antenna, side sill, right

¹Frequency dependent on the national-market version.

When the customer approaches the vehicle with the ID transmitter, the Welcome effect starts at a distance of approx. 3 m (10 ft.).

The graphic shows the driver's side, the function on the passenger's side is identical!

7.2.3. Vehicle unlocking



Vehicle unlocking

Index	Explanation
1	Remote control receiver (FBD)
2	Communication 434 MHz ¹
3	ID transmitter
4	Communication 125 kHz
5	Comfort Access antenna, side sill, left
6	Comfort Access antenna, side sill, right

¹Frequency dependent on the national-market version.

General Vehicle Electronics 2018

7. Comfort Access 2.0

When the customer moves closer to the vehicle with the ID transmitter, the vehicle is unlocked at a distance of approx. 1.5 m (5 ft.).

The graphic shows the driver's side, the function on the passenger's side is identical!

7.2.4. Vehicle locking

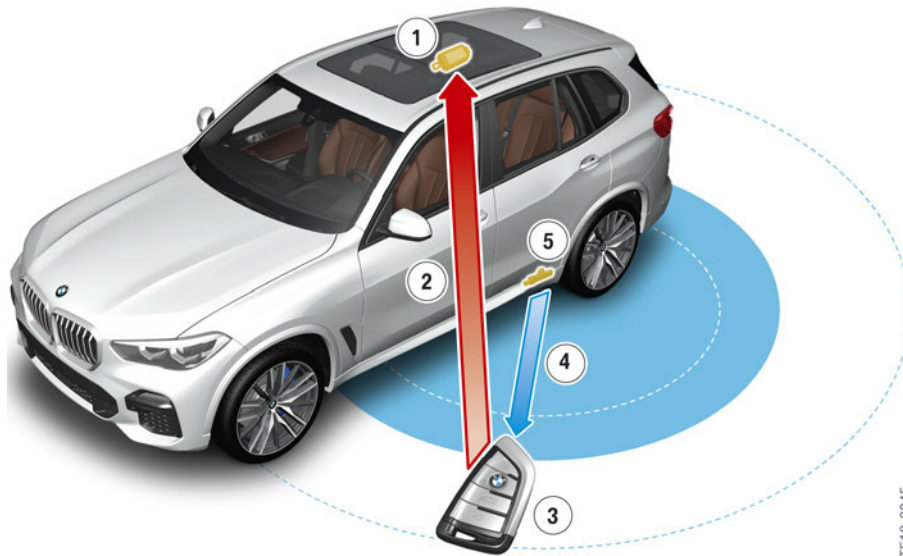

Vehicle locking

Index	Explanation
1	Remote control receiver (FBD)
2	Communication 434 MHz ¹
3	ID transmitter
4	Communication 125 kHz
5	Comfort Access antenna, side sill, left
6	Comfort Access antenna, side sill, right

¹Frequency dependent on the national-market version.

When the customer leaves the vehicle range with the ID transmitter, the vehicle is automatically locked or doublelocked at a distance of approx. 2 m (6 ft.).

The graphic shows the driver's side, the function on the passenger's side is identical!

The customer moves away from the vehicle with the ID transmitter after the driver's door has been opened and closed. The vehicle is automatically locked or doublelocked at a distance of approximately 2 m (6 ft.).

General Vehicle Electronics 2018

7. Comfort Access 2.0

Prerequisites for locking:

- Driver's door opened and closed again
- All doors closed
- No driving readiness

Additional prerequisites for deadlocking:

- Seat belt buckle contact not connected
- Seat occupancy detection does not detect any person

In the course of deadlocking the alarm system is activated in addition to the vehicle being locked.

7.3. Settings

7.3.1. Automatic functions

The following additional functions can be individually set with Comfort Access 2.0:

- Unlock by approaching
- Lock by leaving

Unlock by approaching

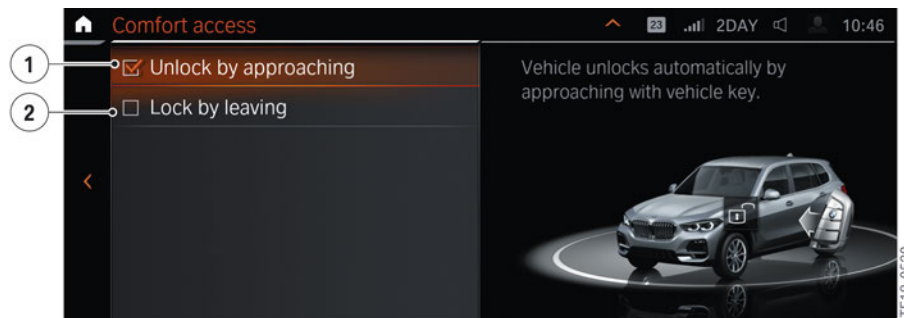

Comfort Access settings

Index	Explanation
1	Unlock by approaching
2	Lock by leaving

General Vehicle Electronics 2018

7. Comfort Access 2.0

Lock by leaving

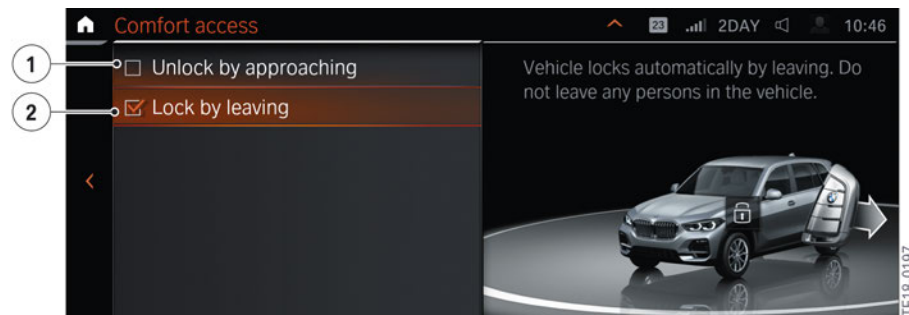

Comfort Access settings

Index	Explanation
1	Unlock by approaching
2	Lock by leaving

7.3.2. Selective unlocking

Selective unlocking can be activated via the Doors / Key menu. Only the driver's door is unlocked with selective unlocking.

7.4. Wiring diagram

The wiring diagram shows Comfort Access 2.0 on the example of the G05.

General Vehicle Electronics 2018

7. Comfort Access 2.0

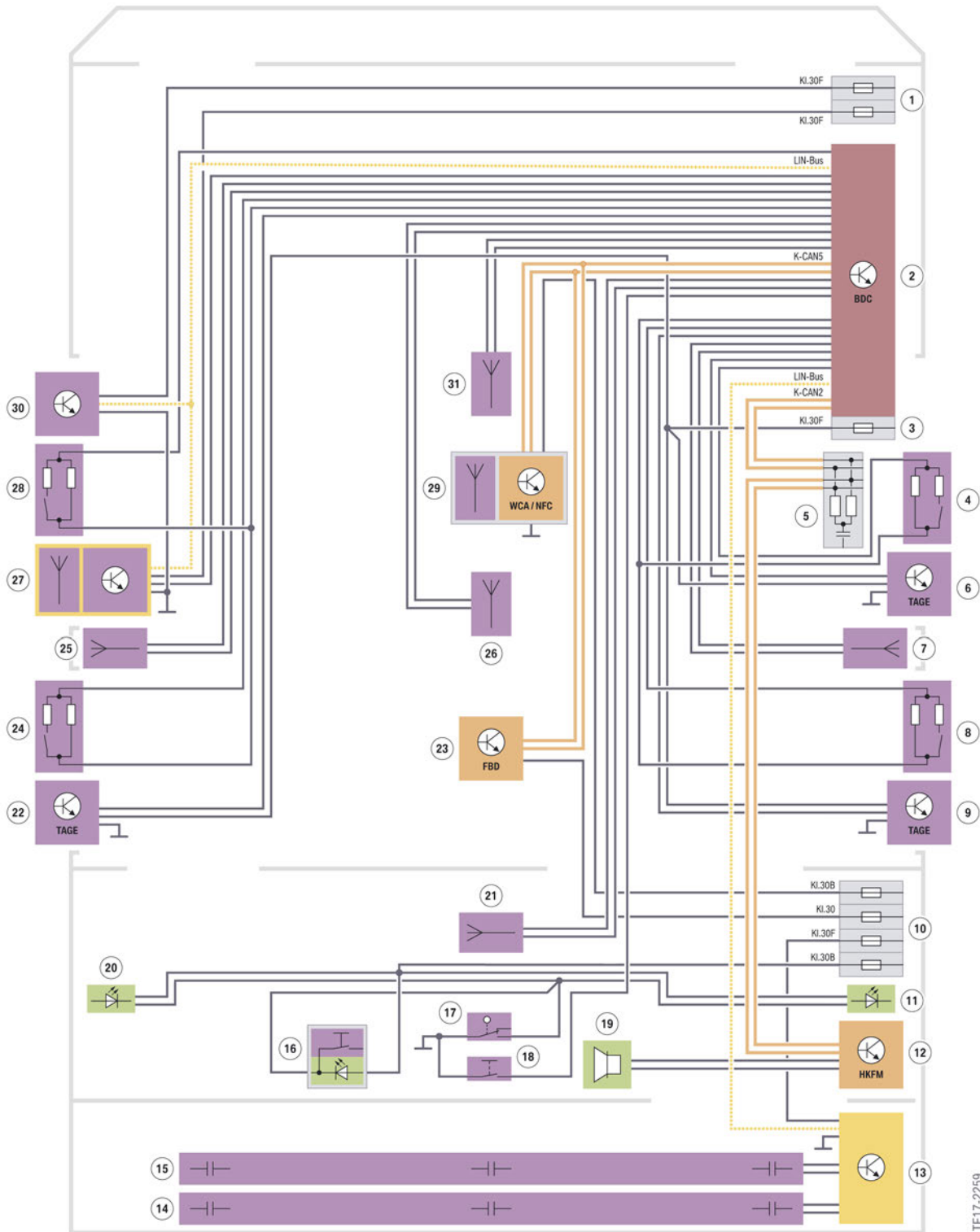

TE17-2259

Comfort Access

General Vehicle Electronics 2018

7. Comfort Access 2.0

Index	Explanation
1	Fuses in the power distribution box, front right
2	Body Domain Controller (BDC)
3	Fuse in the Body Domain Controller
4	Switch in door lock, front passenger door
5	CAN terminator
6	Outside door handle electronics, front passenger (TAGEBF)
7	Comfort Access antenna, side sill, right
8	Switch in door lock, passenger's side rear
9	Outside door handle electronics, passenger's side rear (TAGEBFH)
10	Fuses in the power distribution box, rear right
11	Luggage compartment light, right
12	Tailgate function module HKFM
13	Control unit for contactless tailgate opening
14	Sensor at bottom for contactless tailgate opening
15	Sensor at top for contactless tailgate opening
16	Button for closing tailgate
17	Tailgate contact switch in the tailgate lock
18	Button for tailgate
19	Acoustic warning device for tailgate activation
20	Luggage compartment light, left
21	Comfort Access antenna, luggage compartment
22	Outside door handle electronics, driver's side rear (TAGEFAH)
23	Remote control receiver (FBD)
24	Switch in door lock, driver's side rear
25	Comfort Access antenna, side sill, left
26	Comfort Access antenna, passenger compartment
27	Outside door handle electronics, driver (TAGEFA) with Near Field Communication (NFC)
28	Switch in door lock, driver's side
29	Wireless charging station with control electronics for Near Field Communication (NFC)
30	Power window electronics, driver's side front
31	Comfort Access antenna, passenger compartment

General Vehicle Electronics 2018

8. BMW Digital Key

8.1. Introduction

BMW Digital Key facilitates access to and use of the vehicle by:

- a Samsung smartphone
- or with a Digital Key Card

Only Samsung smartphones are supported at the market introduction of BMW Digital Key.

No ID transmitter is required.

BMW Digital Key is a component part of the optional equipment Comfort Access (SA 322).

8.2. Functions

8.2.1. Unlocking

To unlock the vehicle, the corresponding smartphone or the Digital Key Card must be held close to the outside door handle. The wireless range of NFC is only a few centimeters.

8.2.2. Vehicle starting

To start the vehicle, the corresponding smartphone or the Digital Key Card must be placed in the wireless charging station or NFC station. Then the vehicle can be started by pressing the start/stop button.

8.3. Vehicle components

8.3.1. Outside door handle electronics



Outside door handle with Near Field Communication (NFC)

General Vehicle Electronics 2018

8. BMW Digital Key

To unlock the vehicle, the corresponding smartphone or the Digital Key Card must be held close to the outside door handle. The wireless range of NFC is only a few centimeters.



Outside door handle with Near Field Communication (NFC)

Index	Explanation
1	Electronics in the outside door handle

The outside door handle electronics, driver (TAGEFA) with NFC is installed only in the driver's door and only with the optional equipment Comfort Access (SA 322).

8.3.2. NFC station



NFC station

An NFC station is installed with the optional equipment Comfort Access (SA 322) in vehicles with wireless charging stations.

Feature distinguishing an NFC station from a wireless charging station (WCA/NFC):

General Vehicle Electronics 2018

8. BMW Digital Key

- There is no LED on the NFC station
- An LED for the charging function is incorporated on the wireless charging station (WCA/NFC).

The NFC control unit is not shown by the ISTA diagnosis system in the bus overview. Diagnosis is performed via the Body Domain Controller.

8.3.3. Wireless charging station



Wireless charging station with Near Field Communication (NFC)

The antenna and the control electronics for Near Field Communication have additionally been installed in the wireless charging station.

The wireless charging station (WCA) monitors the charging bay and controls the charging procedure.

The Near Field Communication (NFC) control electronics is required for Near Field Communication in the vehicle. The received NFC data are evaluated by the Body Domain Controller (BDC).

The WCA/NFC control unit is not shown by the ISTA diagnosis system in the bus overview. Diagnosis is performed via the Body Domain Controller.

8.4. Smartphone, Digital Key Card

No key data are stored on the Digital Key Card or on the smartphone at the market introduction of BMW Digital Key. For service purposes the ID transmitter must be used so that the key data can be read out with the KeyReader.

8.4.1. Digital Key Card

The Digital Key Card facilitates access to and use of the vehicle. The Digital Key Card can be activated by the customer in the vehicle via the corresponding iDrive menu. A ConnectedDrive account is **not** required for the Digital Key Card.

General Vehicle Electronics 2018

8. BMW Digital Key

8.4.2. Smartphone

Requirements:

- Supported Samsung smartphone with installed BMW Connected app
- ConnectedDrive account

Only Samsung smartphones from Galaxy class S7 and Android from 8.1 are supported at the market introduction of BMW Digital Key.

The following is required for authorization at the BMW Retailer:

- Vehicle registration document
- Customer's ID card
- ConnectedDrive account

The documents required may differ from country to country. The procedure is always similar to reordering an ID transmitter. The BMW Service Center activates the corresponding services in the ConnectedDrive Dealer Cockpit. The owner determines their Digital Key Code (4-digit), which is also entered during activation by the BMW Service Center in the ConnectedDrive Dealer Cockpit.

The Digital Key is free for 1 year.

More information about BMW Digital Key can be found in the reference manual **ST1857 Infotainment 2018**.



General Vehicle Electronics 2018

9. Wireless Technologies

9.1. Comparison of wireless technologies

Comparison of wireless technologies for vehicle access.

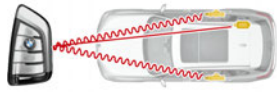
Bluetooth is **not** used for vehicle access in BMW vehicles.

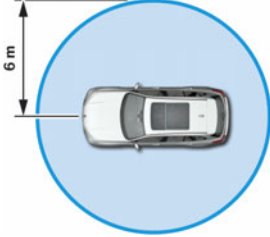
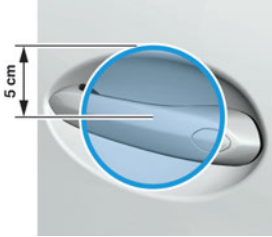
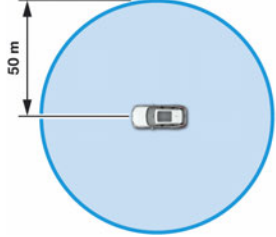
	ID transmitter	NFC	Bluetooth
Frequency	LF ¹ 125 kHz HF ² 434 MHz ³	13.56 MHz	2.4 GHz
Positioning			
	Centimeter-precision positioning by LF ¹	Positioning is implied by short range	Strong reflection Positioning accuracy approx. 1 m
Comfort / range	 6 m	 5 cm	 50 m
	Max. range up to approx. 6 m	Max. range up to approx. 5 m	Max. range up to approx. 50 m
Security	Secure key memory in the ID transmitter Secure hardware	Secure memory in the Secure Element Hardware interface between NFC and Secure Element	Not secure due to possible software manipulation of the operating system

¹LF Low Frequency

²HF High Frequency

³Frequency dependent on the national-market version

General Vehicle Electronics 2018

9. Wireless Technologies

9.1.1. ID transmitter

The ID transmitter can be positioned with centimeter precision. The Comfort Access antennas are activated by the Body Domain Controller (BDC). Communication from the Comfort Access antennas to the ID transmitter is performed at 125 kHz. Depending on its position, the ID transmitter receives the data of:

- the antennas in the side sills
- the antennas in the vehicle interior
- the antennas in the luggage compartment

The ID transmitter transmits, depending on the data received and their field strength, a corresponding message to the remote control receiver. Communication from the ID transmitter to the remote control receiver is performed at 434 MHz (frequency dependent on the national-market version). The data received by the remote control receiver (FBD) are evaluated by the Body Domain Controller. This makes it possible to pinpoint precisely the position of the ID transmitter.

Security against manipulation is ensured by secure hardware.

9.1.2. NFC

Precise positioning is automatically achieved by the short range of NFC.

Security is ensured by a Secure Element in the mobile phone.

9.1.3. Bluetooth

The long range of Bluetooth can give rise to strong reflections and to damping. This makes precise positioning impossible.

Security is not guaranteed due to software-manipulation of the operating system.

General Vehicle Electronics 2018

10. Drive Recorder

10.1. Introduction

The electrical system Service Pack 2018 is the most versatile offering ever to be introduced for BMW vehicles. The following optional equipment for the Service pack 2018 is now available.

The Drive Recorder (SA 6DR) is available for the first time in the following vehicles:

- G15
- G12 LCI

Additional models will be added at a later date.

The following equipment must be installed as a prerequisite for the Drive Recorder:

- BMW TeleService
- BMW Live Cockpit Professional
- Parking Assistant plus

10.2. Function

The Drive Recorder optional equipment uses 4 cameras at the front, in the exterior mirrors and at the rear to generate 360 degree videos of the area around the vehicle. The videos are processed in the TRSVC control unit, stored in the head unit and can be played back on the CID or stored on a USB stick. Important driving data, such as speed and GPS position, are stored with the video.

The Drive Recorder function has 2 sub-functions:

- Event Recorder
- Crash Recorder

The customer can create videos manually using the Event Recorder function. Depending on the setting, the customer can store 10 videos each with a maximum length of 40 seconds on the head unit.

The Crash Recorder function automatically records accidents that occur while driving.

These functions can be activated or deactivated using the controller.

Restrictions will occur if severe accidents occur and the camera system or the head unit is damaged as a result and can not generate any recordings.

General Vehicle Electronics 2018

11. Changelog

In the table below, you will find corrections and updates to this training manual.

Index	Section	Summary of Changes	Date
1	8 BMW Digital Key - entire section	Changed references of “NFC key card” to “Digital Key Card” to remain consistent with ST1857 Infotainment 2018 reference manual.	July 2020
2	8.4 Smartphone, Digital Key Card	Removed sentence about possibility to store key (service) data on NFC card and smartphone as this is not confirmed at this time.	July 2020
3	8.4.2 Smartphone	Removed sentence about the owner of the Digital Key being able to "pass on" additional keys as this is not applicable for our market.	July 2020
4	8.4.3 Activating an additional smartphone (Friends Digital Key)	Removed this section as it is not applicable for our market.	July 2020

